

NOVA LUCE

9005650

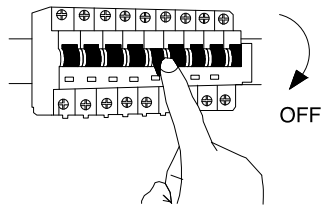

1. Turn off the general switch

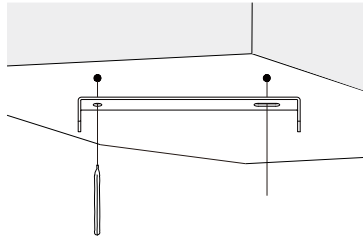

2. Mark where to drill holes

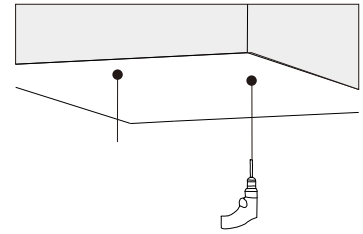

3. Drill on the marked areas

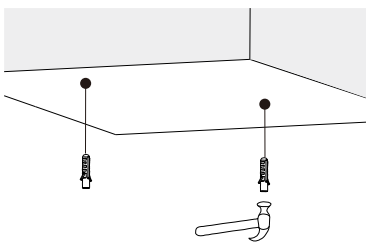

4. Apply plastic anchors

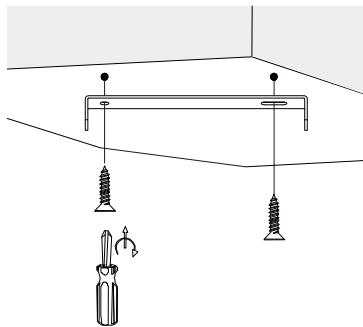

5. Apply screws

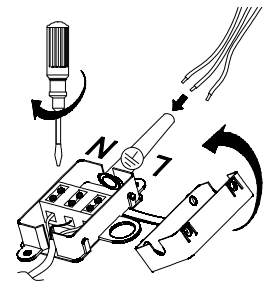

6. Connect the wires

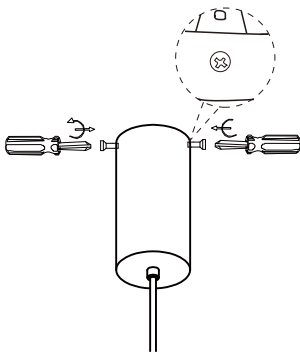

7. Apply the product by rotating

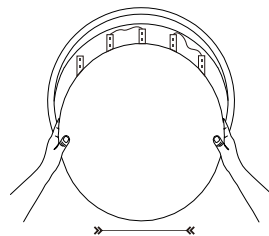

8. Put the product in place

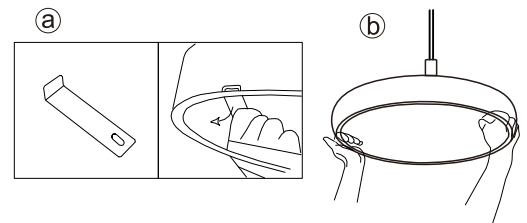

9. With the extra tool adjust the product

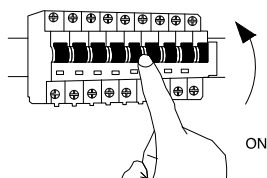

10. Turn on the general switch

