

# BUCKET 976A-L3310B-04 Wall Bracket BUCKET IP65 LED SMD 10.50W 1770lm CRI80 4000K Anthracite

Bucket family is made up of the wall light and the beacon, made of aluminum in anthracite color with IP65. Available in two color temperatures 3000K and 4000K and phase C cut version. Recommended for installations in residential areas.

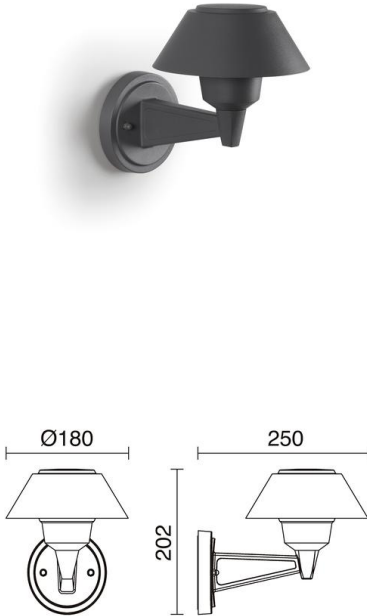

## GENERAL DATA

Category	Surface
Family	Bucket
Finish	[04] Anthracite
Location	Outdoor
Installation	Wall
Body material	Aluminum
Diffuser material	Opal polycarbonate
ETIM class	EC0028g2
EAN	8433264114992

## LIGHT SOURCES AND BEAMS

Sources	LED SMD 10.5W max. 1770lm 4000K CRI80
Total flux	545 lm
Energy efficiency	C

## TECHNICAL DATA

Dimensions	Diameter x Height x Width (mm): 180 x 202 x 250
IP	IP65
IK	08
Protection class	Class I
Frequency	50/60 Hz
Input voltage	220-240V AC V
Output current	300 mA
Power factor	0.9
Auxiliary gear	Electronic
Auxiliary equipment brand	HEP
Operating temperature range	-30 - 45 °C
Lifetime	50,000 h
LED lifetime L	70
LED lifetime B	50
Weight	1.04 Kg
Cable outlets	1
ECORAAE category I	LED-B
ECORAAE I	0.4

## NOTES

Consult power option at 110V-277V

# BUCKET

976A-L3310B-04 Wall Bracket BUCKET IP65 LED SMD 10.50W 1770lm CRI80 4000K Anthracite

## PRODUCTS OF THE SAME FAMILY

---



Bucket H300



Bucket H600