



# Installation

## VK/02281

SINCE 1978



LEADING LIGHT

Please read the instructions carefully before commencing assembly

### LED LAWN LIGHT

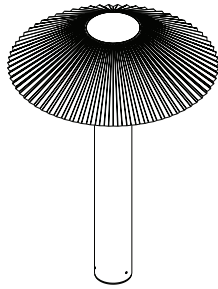

#### (E) Warnings:

##### General use

- The lamp gets hot after prolonged use, therefore, do not cover the product.

##### Cleaning instructions

- Before cleaning, ensure that the power supply is switched off. Wipe surface of lamp shade with a soft cloth.
- Do not use any abrasive cleaning tools such as steel wool, scouring sponges or stiff brushes.
- Never use strong cleaning agents such as white spirit, household glass cleaner or cellulose thinners.

##### Safety precautions

- The appliance should be installed, connected and tested by qualified electrician and in accordance with local regulations.
- Turn off the power supply before installation or maintenance of the lamp, and make sure that the cables are not squeezed or damaged by sharp edges during installation.
- The lamp should not be covered by insulation blankets or similar materials.

1

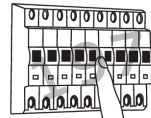

TURN OFF POWER!  
COUPEL LE COURANT!  
STROMABSHALTEN!  
CORTE CORRIENTE!

2

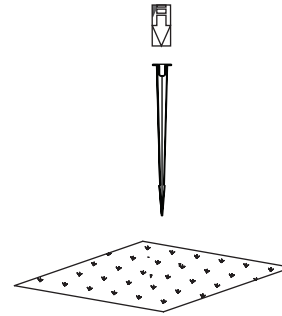

3

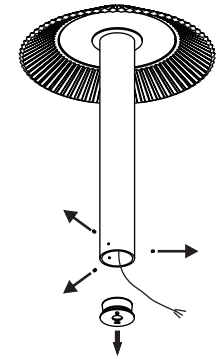

4

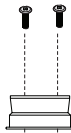

5

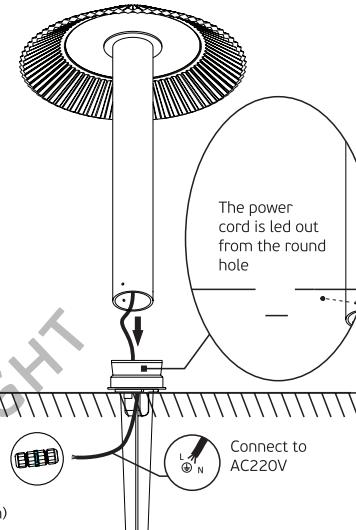

Use waterproof connector to connect power supply (Bring your own)

Connect to AC220V

6

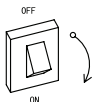
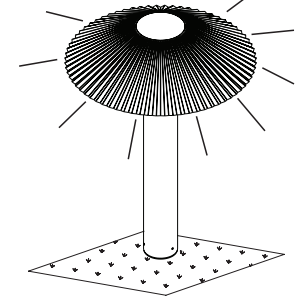

Triac Dimmable

VK Leading Light / Vaios I. Karakostas S.A. Imports - Exports Trade

A: 8 Aristotelous St, Tavros, 177 78 Athens, Greece T: +30 210 99 69 610-11, +30 210 34 58 072, +30 210 34 58 075

F: +30 210 99 58 374 E: info@vkleadinglight.gr W: vkleadinglight.gr