

DC365 DC368

USER MANUAL LED RECESSED DOWNLIGHT

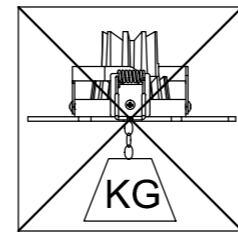

- 01.MAKE HOLE PATTERN
- 02.SWITCH OFF MAIN
- 03.PUT THE LAMP EACH BY EACH INTO THE CEILING AND CONNECT EACH OTHER AS DRAWING SHOWS
- 04.CONNECT POWER-SUPPLY TO THE MAIN
- 05.CONNECT THE LAMP TO POWER SUPPLY
- 06.SWITCH ON THE MAIN AND LIGHT ON

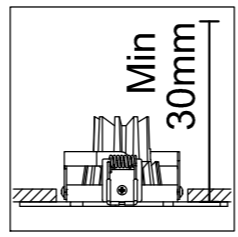
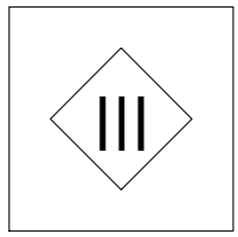
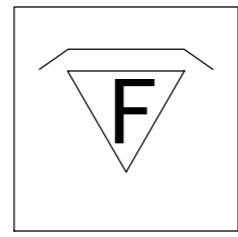
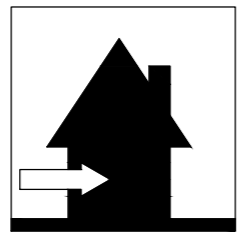
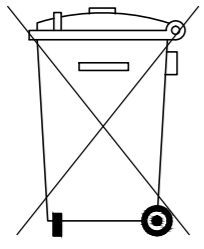
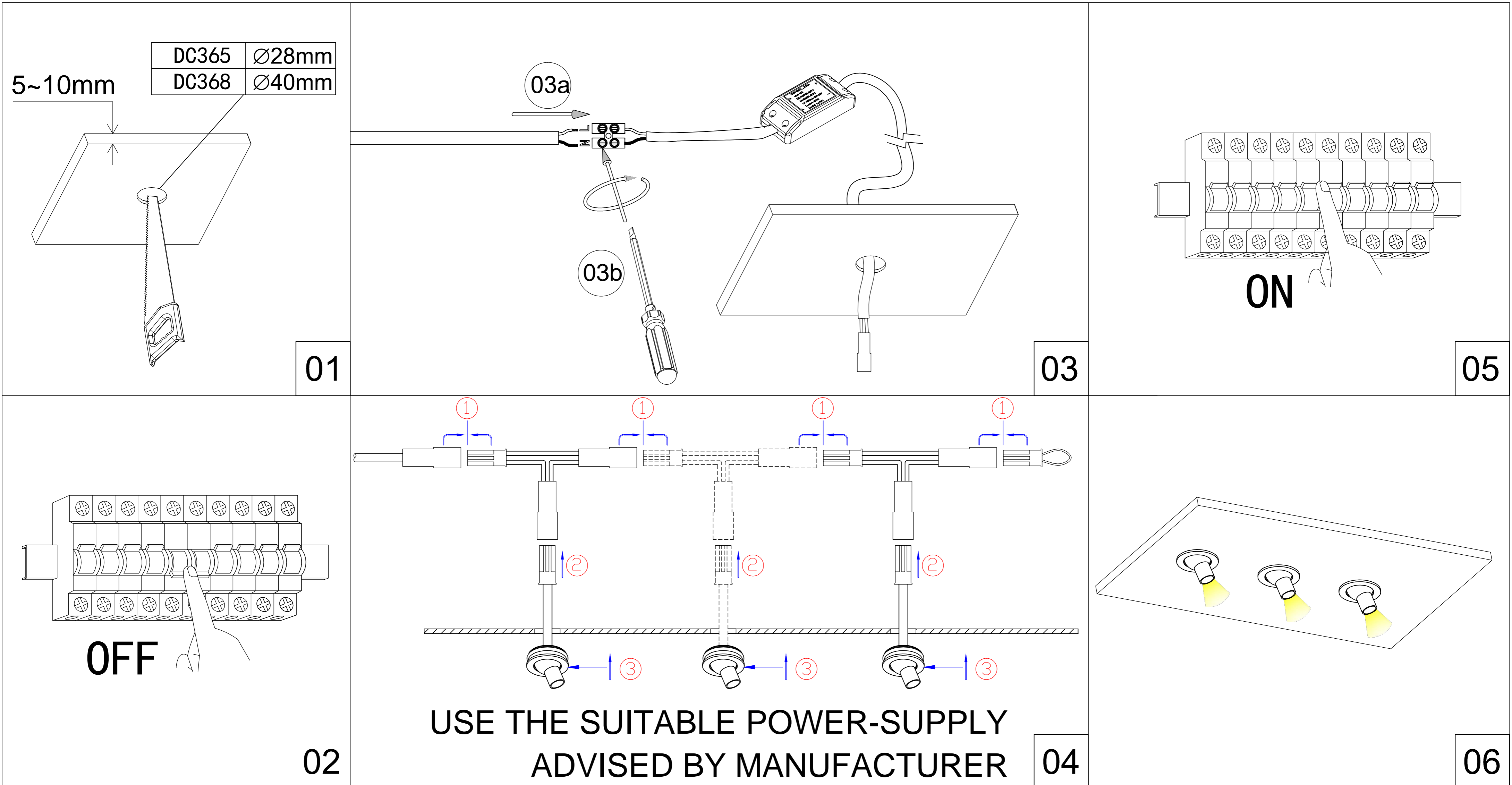
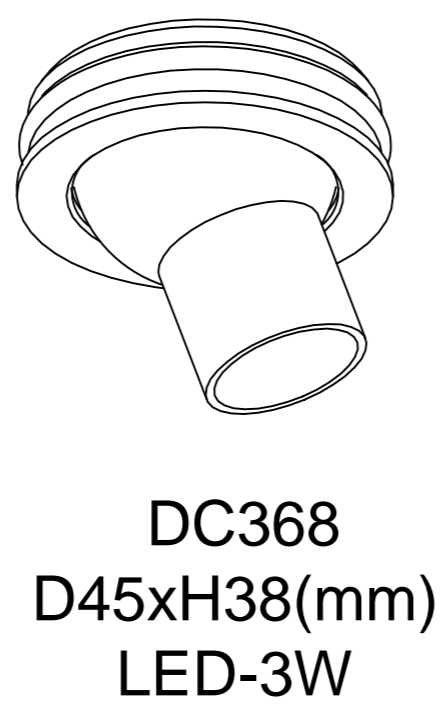

Lamp:CREE XPE LED
 Color: 2700K/3000K/4000K/6000K
 Color rendering: Ra80
 Input: 100V-240V AC
 Current: Constant 300/600mA
 Frequency: 50/60Hz
 Watt: 1W/3W
 Life span: 20,000hrs
 Operating temp: -20°C--+40°C
 Indoor use only
 IP20
 Dimmable: NO

Cautions: a.Installed by qualified electrician
 b.Use only power-supply supplied by manufacturer for products guarantee