

INSTRUCCIONES / INSTRUCTIONS / INSTRUCTIONS

DISC

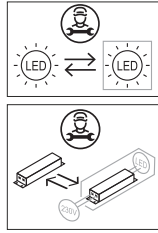

1000A-L3109B10 1000A-L3109B30 1000A-L3109B50
 1000A-L3309B10 1000A-L3309B30 1000A-L3309B50
 1000A-L3113B10 1000A-L3113B30 1000A-L3113B50
 1000A-L3313B10 1000A-L3313B30 1000A-L3313B50

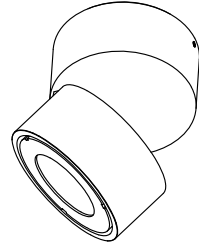
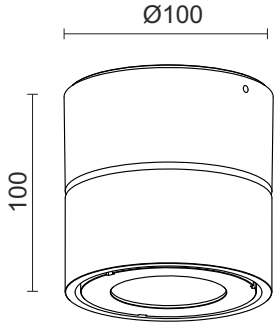

ACCESORIOS
ACCESSORY
ACCESSOIRE

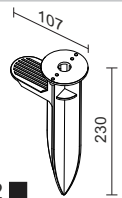

A05A-1000A-02

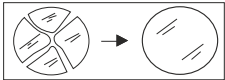

Cristal/Glass/cristal

No utilizar el producto en caso de rotura del cristal y contactar con el fabricante para su sustitución! Should the glass break, the product cannot be used and you should contact the manufacturer for its replacement! En cas d'endommagement de l'écran de protection le produit ne peut pas être utilisé, contactez le fabricant pour le remplacement.



ES: Este producto contiene una fuente luminosa de la clase de eficiencia energética F.
 EN: This product contains a light source with energy efficiency class F.
 F: Ce produit comprend une ampoule de la classe d'efficacité énergétique F.

ES: La seguridad de la luminaria se garantiza solo cumpliendo las siguientes instrucciones; por ello, es necesario conservarlas.
 EN: The safety of this luminaire is guaranteed only if you comply with these instructions; remember to conserve in a safe place.
 F: La sécurité des luminaire est seulement garantie répondant aux instructions suivantes; Il est donc nécessaire de les

ES: Asegurese que la tensión de red y frecuencia sea la adecuada al equipo.
 EN: Ensure adequate voltage and frequency is supplied to the equipment.
 F: Assurez-vous que la tension et la fréquence soit celle qui s'adapte à l'alimentation.

ES: Desconectar del suministro eléctrico antes de manipular o realizar cualquier tipo de mantenimiento.
 EN: Disconnect from the main power before performing or any maintenance.
 F: Couper l'alimentation électrique avant de manipuler ou d'effectuer toute opération d'entretien.

ES: La instalación debe realizarse por personal cualificado.
 EN: The installation should be carried out by qualified personnel.
 F: L'installation doit être effectuée par du personnel qualifié.

ES: La fuente de luz de esta luminaria es reemplazable unicamente por el fabricante, su servicio tecnico o personal autorizado.
 EN: The light source contained in this luminaire shall only be replaced by the manufacturer or his service agent or a similar qualified person.
 F: La source lumineuse contenue dans ce luminaire ne doit être remplacée que par el fabricant ou son agent de maintenance ou une personne de qualification équivalente

ES: Apto para uso interior y exterior en conformidad con el IP indicado.
 EN: Suitable for indoor and outdoor use, taking the indicated IP rating into consideration.
 F: Convient a usage interieur et exterior, prenant en compte l'IP indiquée.



lighting
Cristher

NOVOLUX Lighting, SL.
 C/ Ramón Berenguer, 8 (Polígono Industrial Can Vinyals)
 08130 Sta. Perpeta de Mogoda - BARCELONA - España/Spain/Espagne
 ESPAÑA- PORTUGAL: Tel. +93 274 52 52 E-mail: info@novoluxlighting.com
 REST OF THE WORLD: Phone +34 93 516 20 05 E-mail: export@novoluxlighting.com
 Fax +34 933 463 751 / 933 114 546 www.novoluxlighting.com

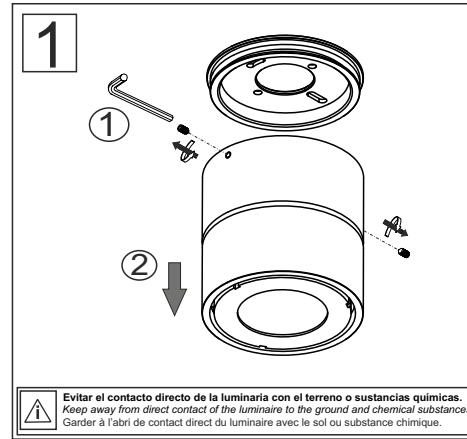

Evitar el contacto directo de la luminaria con el terreno o sustancias químicas.
 Keep away from direct contact of the luminaire to the ground and chemical substances.
 Garder à l'abri de contact direct du luminaire avec le sol ou substance chimique.

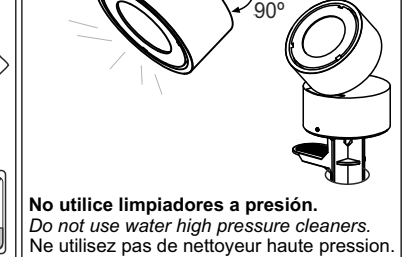
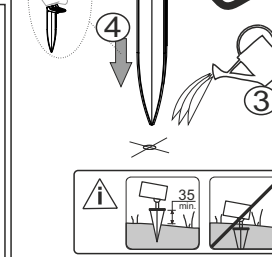
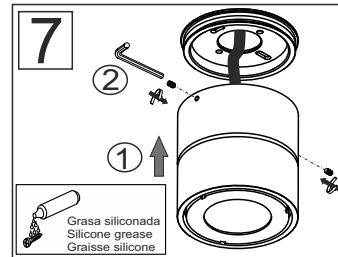
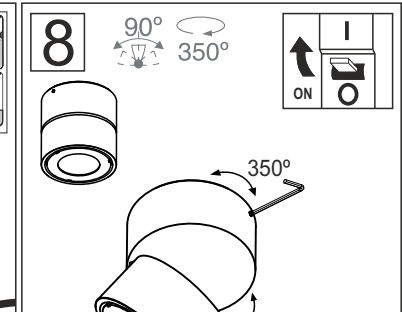
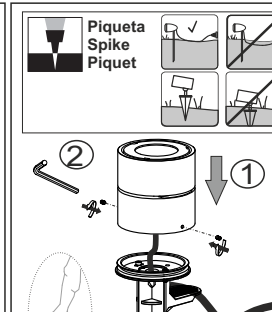
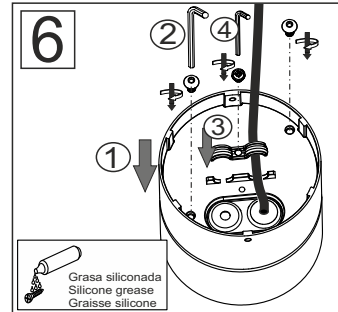
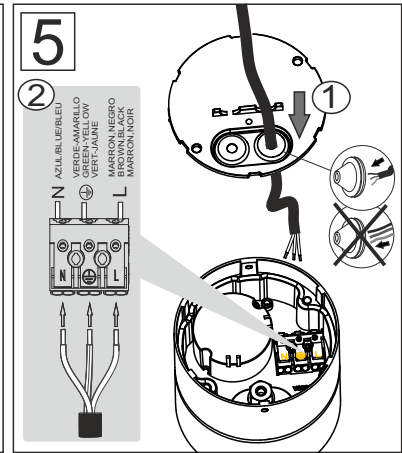
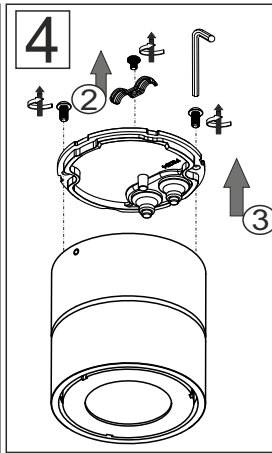
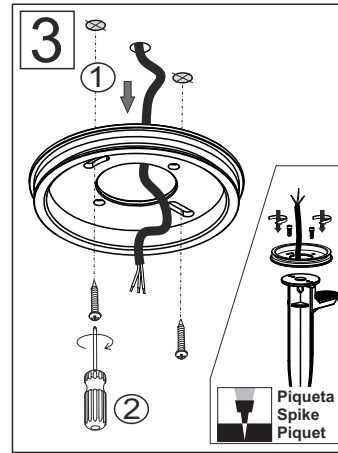
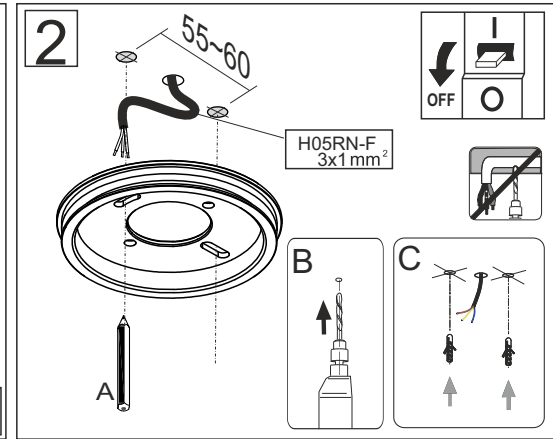

No utilice limpiadores a presión.
 Do not use water high pressure cleaners.
 Ne utilisez pas de nettoyeur haute pression.

INFORMACION IMPORTANTE / IMPORTANT INFORMATION / INFORMATIONS IMPORTANTES

Datos técnicos: véase la etiqueta de la luminaria INSTRUCCIONES DE SEGURIDAD	ESPAÑOL	Technical data: see fixture label SAFETY INSTRUCTIONS	ENGLISH	Caractéristiques techniques : voir l'étiquette de la lampe CONSIGNES DE SECURITE	Français
<p>1. Las conexiones eléctricas sólo pueden llevarse a cabo por parte de personal especializado.</p> <p>2. Preste atención a que, antes de iniciar las operaciones de montaje, quede sin tensión eléctrica el conductor de la red, se extraiga el fusible o bien se deje el interruptor en la posición de "DESCONECTADO". La conexión a la red se realizará por medio de la correspondiente caja de conexión como viene explicado en las figuras.</p> <p>3. Apto para uso interior y exterior en conformidad con el IP indicado.</p> <p>4. No monte la luminaria en superficies húmedas, recién pintadas o que presenten conductibilidad eléctrica.</p> <p>5. Conectar los cables de la luminaria con los del mismo color que salen de la pared o techo.</p> <p>6. Utilizar sistemas de sujeción acordes con el peso del aparato.</p> <p>7. Alejar siempre las conexiones y los cables de los puntos de calor.</p> <p>8. Asegúrese de que los conductos de la instalación no resulten deteriorados por los tornillos de sujeción.</p> <p>9. Guarde las instrucciones en un lugar seguro.</p> <p>10. Utilizar protectores para los cables de alimentación.</p> <p>11. Los cuidados se limitan a superficies, pantallas, vidrios, reflectores y revestimientos. Las luminarias doradas o de latón sólo deben limpiarse con un paño humedecido (sin productos de limpieza). Hay que prestar atención a que no penetre humedad en las conexiones eléctricas.</p> <p>12. Nuestros productos pueden estar sujetos a cambios, por ello no nos responsabilizamos que toda la información técnica este actualizada. En caso de preguntas, no dude en llamar a nuestro departamento de atención al cliente.</p> <p>13. Si el cable o cordón de esta luminaria está dañado, deberá sustituirse exclusivamente por el fabricante, su servicio técnico o una persona de cualificación equivalente para evitar cualquier riesgo.</p> <p>14. Bajo ninguna circunstancia la luminaria debe ser cubierta.</p> <p>15. No utilizar luminarias con cristales dañados o rotos, hasta no ser sustituidos.</p> <p>16. No colgar ni apoyar elementos sobre las luminarias.</p> <p>17. El cable de alimentación no debe colocarse bajo tierra.</p>		<p>1. Electrical appliances must only be connected by competent persons.</p> <p>2. Important! Before commencing installation work disconnect the mains cable from the power supply - remove fuse or turn switch to "OFF"! The power supply connection must be done with the suitable connecting box, as seen on illustrations.</p> <p>3. Suitable for indoor and outdoor use, taking the indicated IP rating into consideration.</p> <p>4. Do not attach luminaires to surfaces which are damp, freshly painted, or otherwise electrically conductive.</p> <p>5. Connect the wires of the luminaire to the wires of the same colour that come from the wall or ceiling.</p> <p>6. Use support systems that are in accordance to the weight of the luminaire.</p> <p>7. Keep the wires and connections separated from any heat source.</p> <p>8. To avoid damage to concealed wiring during installation, establish the direction of the supply cable before drilling fixing holes.</p> <p>9. Keep these instructions in a safe place.</p> <p>10. Use sleeves to cover the mains supply wiring to the fitting.</p> <p>11. Cleaning is limited to the outer surfaces, shades or protective glass, reflectors and covers. Gold-finish and brass luminaires must be only be cleaned with a soft cloth (do not use cleaning agents of any kind). It is important to ensure that no moisture enters the terminal compartment or reaches any live parts!</p> <p>12. As our products are subject to technical modifications, we cannot guarantee, that all information is always up to date. Please contact our technical department with any queries.</p> <p>13. If the external flexible cable or cord of this luminaire is damaged, it shall be exclusively replaced by the manufacturer or his service agent or a similar qualified person in order to avoid a hazard.</p> <p>14. Do not cover the luminaires with insulating material.</p> <p>15. Do not use luminaires with frayed or cracked glass, until it is replaced</p> <p>16. Not hang or supporting elements on the luminaires.</p> <p>17. The cable of the luminaire may not be placed underground.</p>		<p>1. Les branchements ne doivent être confiés qu'à une personne compétente.</p> <p>2. Attention ! Couper la ligne d'alimentation avant de commencer les travaux d'assemblage ; retirer le fusible ou mettre l'interrupteur sur "ARRET" ! Pour le branchement à la ligne d'alimentation voir les figures ci-dessous.</p> <p>3. Convient à usage intérieur et extérieur, prenant en compte l'IP indiquée.</p> <p>4. Ne pas monter la lampe sur une surface de fixation humide, récemment peinte ou susceptible d'être conducteur électrique.</p> <p>5. Réalisez la connexion des câbles de la lampe avec ceux de la même couleur sortant du mur ou du plafond.</p> <p>6. Utilisez les systèmes de fixation correspondants, en fonction du poids de l'appareil.</p> <p>7. Maintenez toujours les connexions et les câbles éloignés des sources de chaleur.</p> <p>8. Assurez-vous que les vis de fixation de la lampe ne peuvent endommager les conduites d'installation.</p> <p>9. Nous vous conseillons de conserver ce mode d'emploi.</p> <p>10. Utilisez protecteurs pour les câbles d'alimentation.</p> <p>11. L'entretien se limite aux surfaces extérieures, aux écrans ou aux verres, aux réflecteurs et aux caches. Veiller à ce que l'humidité en puisse pas s'infiltrer dans les boîtes de jonction ou sur les pièces conductrices de courant. Nettoyer les lampes dorées ou en laiton qu'avec un chiffon doux et humide (sans produit nettoyant).</p> <p>12. Nos produits sont susceptibles d'être modifiés techniquement ou optimisés. Par conséquent, nous ne pouvons pas garantir que toutes les informations de cette fiche technique soient à jour. Notre service technique se tient à votre entière disposition pour toute information.</p> <p>13. Si le câble flexible de ce luminaire est endommagé, seul le fabricant ou l'assistance technique doivent le remplacer pour éviter tout risque.</p> <p>14. Ne pas couvrir le luminaire avec du matériau isolant.</p> <p>15. Les luminaires avec un filtre endommagé ou cassé seront mis hors service jusqu'au remplacement de celui-ci.</p> <p>16. Ne rien pendre ni appuyer sur les luminaires.</p> <p>17. Le câble de la lampe ne doit pas être posé sous terre</p>	



ES Componente de control reemplazable por un profesional.
EN Replaceable control gear by a professional.
F Appareils de contrôle remplaçables par un professionnel.



ES Componente de control reemplazable por el usuario final.
EN Replaceable control gear by an end-user.
F Appareil de commande remplaçable par l'utilisateur final.













ES Fuente de luz reemplazable por un profesional.
EN Replaceable light source by a professional.
F Remplacez le verre de sécurité fissuré.





ES Fuente de luz reemplazable por el usuario final.
EN Replaceable light source by an end-user.
F Remplacer la source lumineuse par un utilisateur final.





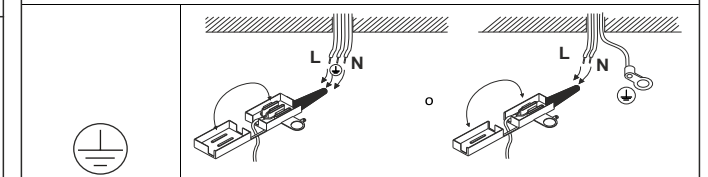



SIMBOLOGÍA / SYMBOLOGY / SYMBOLISME:

	<p>ES Clase de protección I: La luminaria dispone de un conector para el cable de protección (toma tierra).</p> <p>EN Protection class I: This luminaire has an earth terminal.</p> <p>F Classe de protection I: Ce luminaire dispose d'un connecteur pour le câble de protection.</p>		<p>ES Luminaria empotrada no adecuada para montaje en normalmente superficies inflamables</p> <p>EN Recessed luminaire not suitable for direct mounting on normally flammable surfaces</p> <p>F Luminaire construit non approprié pour le montage sur des surfaces normalement inflammables.</p>
	<p>ES Clase de protección II: La luminaria tiene doble aislamiento y no se debe conectar a un cable de protección</p> <p>EN Protection class II: This luminaire is doubly insulated and must not be connected to and earth wire.</p> <p>F Classe de protection II: Ce luminaire a un double isolement et il ne faut pas le connecter à un câble de protection.</p>		<p>ES Luminaria superficial no adecuada para montaje en superficies normalmente inflamables</p> <p>EN Surface luminaire not suitable for direct mounting on normally flammable surfaces.</p> <p>F Luminaire superficiel non approprié pour le montage sur des surfaces normalement inflammables.</p>
	<p>ES Clase de protección III: Luminaria para muy baja tensión de protección (MBTS).</p> <p>EN Protection class III: Luminaire for protective low voltage (SELV)</p> <p>F Classe de protection III: Luminaire pour la protection de basse pression (SELV).</p>		<p>ES Luminaria no adecuada para cubrirse con material aislante térmico</p> <p>EN Luminaires not suitable for covering with thermally insulating material</p> <p>F Ne pas recouvrir le luminaire avec du matériau isolant.</p>
	<p>ES Distancia mínima de los objetos iluminados.</p> <p>EN Minimum distance from lighted objects</p> <p>F Distance minimale des objets éclairés</p>		<p>ES Sustituir pantalla de protección con fisuras.</p> <p>EN Replace any cracked protective Shield</p> <p>F Remplacez le verre de sécurité fissuré.</p>
	<p>ES Baja Presión= Luminaria diseñada para la utilización únicamente de lámparas halógenas de volframio autoprotegidas</p> <p>EN Low pressure: For luminaires which are designed for use with self-shielded tungsten halogen lamps only.</p> <p>F Basse pression = Luminaire dessiné pour l'utilisation uniquement avec lampes halogènes de tungstène auto</p>		<p>ES El símbolo de la papelera tachada en el aparato o en el embalaje, indica que el producto al final de su vida deberá eliminarse por separado de los demás desechos.</p> <p>EN Where affixed on the equipment or package, the barred waste bin sign indicates that the product must be separated from other waste at the end of its working life for disposal.</p> <p>F Le symbole avec la poubelle barrée, mis sur l'appareillage ou sur l'emballage,</p>

CONEXIÓN A RED / SUPPLY CONNECTION / CONNECTER AU RÉSEAU:







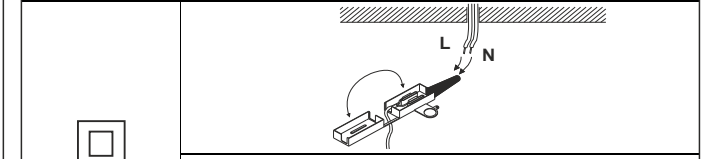



MARRÓN, NEGRO / BROWN, BLACK MARRON, NOIR			
VERDE Y AMARILLO / GREEN AND YELLOW VERT ET JAUNE			
AZUL / BLUE / BLEU			

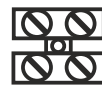



MARRÓN, NEGRO / BROWN, BLACK MARRON, NOIR			
AZUL / BLUE / BLEU			

 **IP65** ES: Protegido contra la penetración de polvo y chorros de agua.
EN: Dust tight and protected against jets of water.
F: Totalement protégé contre la poussière et les jets d'eau.