

**INSTRUCCIONES / INSTRUCTIONS / INSTRUCTIONS**

**LULU**

572A-G21X1A



110-240V~  
50/60 HZ



IP66



Lampàra / Bulb / Lampe  
(no incluida/not included/exclu)

GU10 Max. 3.5W

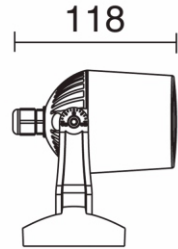
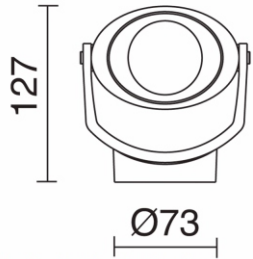
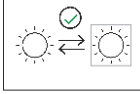

ACCESORIOS  
ACCESSORY  
ACCESSOIRE



A05A-409-02



**ES:** La seguridad de la luminaria se garantiza solo cumpliendo las siguientes instrucciones; por ello, es necesario conservarlas.  
**EN:** The safety of this luminaire is guaranteed only if you comply with these instructions; remember to conserve in a safe place.  
**F:** La sécurité des luminaire est seulement garantie répondant aux instructions suivantes; Il est donc nécessaire de les

**ES:** Asegúrese que la tensión de red y frecuencia sea la adecuada al equipo.  
**EN:** Ensure adequate voltage and frequency is supplied to the equipment.  
**F:** Assurez-vous que la tension et la fréquence soit celle qui s'adapte à l'alimentation.

**ES:** Desconectar del suministro eléctrico antes de manipular o realizar cualquier tipo de mantenimiento.  
**EN:** Disconnect from the main power before performing or any maintenance.  
**F:** Couper l'alimentation électrique avant de manipuler ou d'effectuer toute opération d'entretien.

**ES:** La instalación debe realizarse por personal cualificado.  
**EN:** The installation should be carried out by qualified personnel.  
**F:** L'installation doit être effectuée par du personnel qualifié.

**ES:** Apto para uso interior y exterior en conformidad con el IP indicado.  
**EN:** Suitable for indoor and outdoor use, taking the indicated IP rating into consideration.  
**F:** Convient a usage intérieur et extérieur, prenant en compte l'IP indiqué.



**Dopo**  
lighting

NOVOLUX Lighting, SL.  
C/ Ramón Berenguer, 8 (Polígono Industrial Can Vinyals)  
08130 Sta. Perpetua de Mogoda - BARCELONA - España/Spain/Espagne  
ESPAÑA- PORTUGAL: Tel. +93 274 52 52 E-mail: info@novoluxlighting.com  
REST OF THE WORLD: Phone +34 93 516 20 05 E-mail: export@novoluxlighting.com  
Fax +34 933 463 751 / 933 114 546 www.novoluxlighting.com



**Evitar el contacto directo con el terreno o sustancias químicas.**  
*Keep away from direct contact to the ground and chemical substances.*  
Garder à l'abri de contact direct avec le sol ou substance chimique.



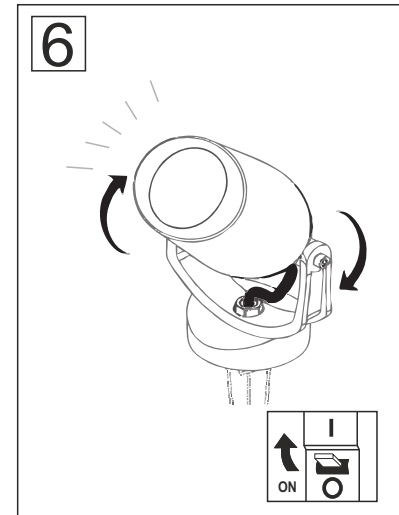
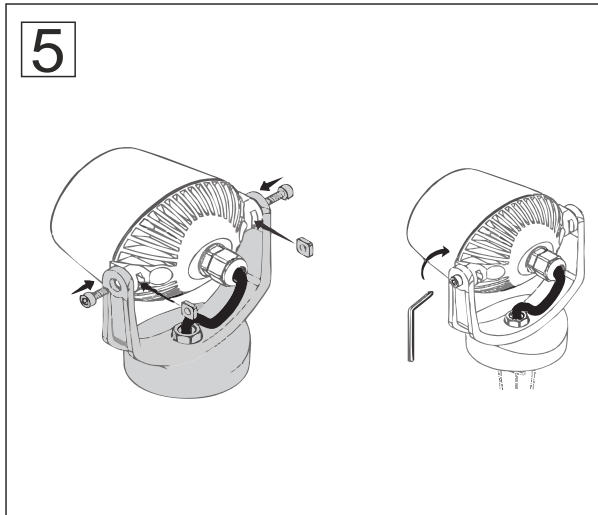
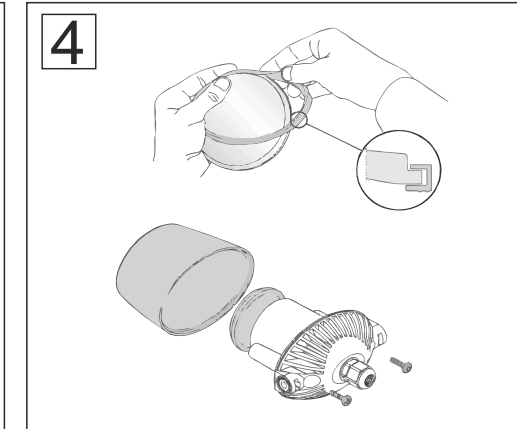
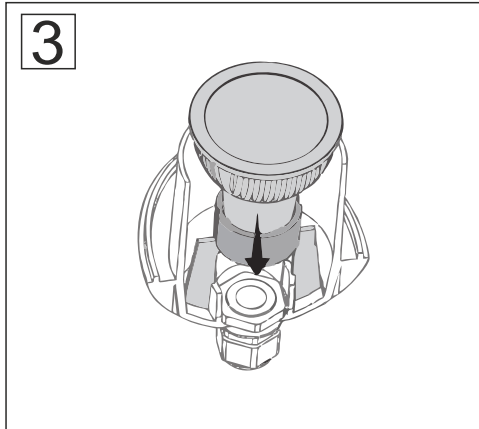
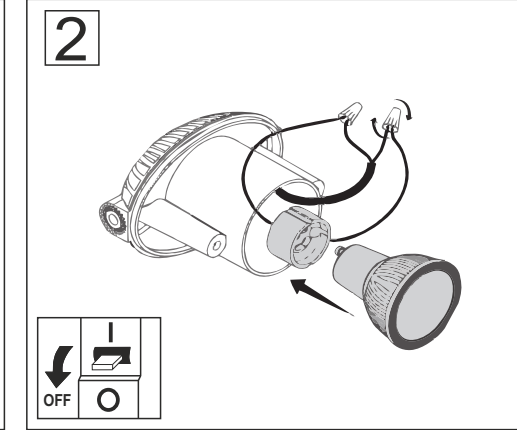
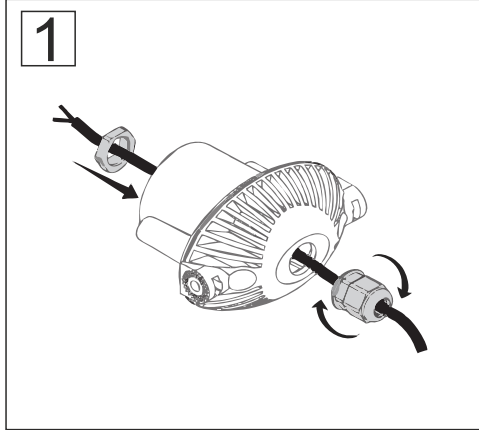

Asegúrese que el difusor queda totalmente cerrado.  
Make sure that the diffuser is totally closed.  
Assurer que le diffuseur est totalement fermé

**No utilice limpiadores a presión.**  
*Do not use water high pressure cleaners.*  
Ne utilisez pas de nettoyeur haute pression.

















# INFORMACION IMPORTANTE / IMPORTANT INFORMATION / INFORMATIONS IMPORTANTES



Datos técnicos: véase la etiqueta de la luminaria	ESPAÑOL	ENGLISH	FRANCAIS
<p><b>INSTRUCCIONES DE SEGURIDAD</b></p> <ol style="list-style-type: none"> <li>Las conexiones eléctricas sólo pueden llevarse a cabo por parte de personal especializado.</li> <li>Preste atención a que, antes de iniciar las operaciones de montaje, quede sin tensión eléctrica el conductor de la red, se extraiga el fusible o bien se deje el interruptor en la posición de "DESCONECTADO". La conexión a la red se realizará por medio de la correspondiente caja de conexión como viene explicado en las figuras.</li> <li>Esta luminaria es solo adecuada para su utilización en interiores (no en lugares húmedos) y sólo puede utilizarse de acuerdo a su tipo de construcción. Máxima temperatura ambiente permitida 25°C.</li> <li>No monte la luminaria en superficies húmedas, recién pintadas o que presenten conductibilidad eléctrica.</li> <li>Conectar los cables de la luminaria con los del mismo color que salen de la pared o techo.</li> <li>Utilizar sistemas de sujeción acordes con el peso del aparato.</li> <li>Alejar siempre las conexiones y los cables de los puntos de calor.</li> <li>Asegúrese de que los conductos de la instalación no resulten deteriorados por los tornillos de sujeción.</li> <li>Guarde las instrucciones en un lugar seguro.</li> <li>Utilizar protectores para los cables de alimentación.</li> <li>Los cuidados se limitan a superficies, pantallas, vidrios, reflectores y revestimientos. Las luminarias doradas o de latón sólo deben limpiarse con un paño humedecido (sin productos de limpieza). Hay que prestar atención a que no penetre humedad en las conexiones eléctricas.</li> <li>Nuestros productos pueden estar sujetos a cambios, por ello no nos responsabilizamos que toda la información técnica este actualizada. En caso de preguntas, no dude en llamar a nuestro departamento de atención al cliente.</li> <li>(Tipo Y) Si el cable o cordón de esta luminaria está dañado, deberá sustituirse exclusivamente por el fabricante, un servicio técnico o una persona de cualificación equivalente para evitar cualquier riesgo.</li> <li>Bajo ninguna circunstancia la luminaria debe ser cubierta.</li> <li>No utilizar luminarias con cristales dañados o rotos, hasta no ser sustituidos.</li> <li>No colgar ni apoyar elementos sobre las luminarias.</li> <li>Si el cable flexible o cordón de esta luminaria está dañado, debe sustituirse exclusivamente por el fabricante o su servicio técnico o una persona de cualificación equivalente con objeto de evitar cualquier riesgo.</li> </ol>	<p><b>Technical data: see fixture label</b></p> <p><b>SAFETY INSTRUCTIONS</b></p> <ol style="list-style-type: none"> <li>Electrical appliances must only be connected by competent persons.</li> <li>Important! Before commencing installation work disconnect the mains cable from the power supply - remove fuse or turn switch to "OFF"! The power supply connection must be done with the suitable connecting box, as seen on illustrations.</li> <li>This luminaire is only suitable for use in living areas (not for areas subject to moisture) and may be used only in accordance with its particular design. The maximum permissible ambient temperature is 25°C.</li> <li>Do not attach luminaires to surfaces which are damp, freshly painted, or otherwise electrically conductive.</li> <li>Connect the wires of the luminaire to the wires of the same colour that come from the wall or ceiling.</li> <li>Use support systems that are in accordance to the weight of the luminaire.</li> <li>Keep the wires and connections separated from any heat source.</li> <li>To avoid damage to concealed wiring during installation, establish the direction of the supply cable before drilling fixing holes.</li> <li>Keep these instructions in a safe place.</li> <li>Use sleeves to cover the mains supply wiring to the fitting.</li> <li>Cleaning is limited to the outer surfaces, shades or protective glass, reflectors and covers. Gold-finish and brass luminaires must be only be cleaned with a soft cloth (do not use cleaning agents of any kind). It is important to ensure that no moisture enters the terminal compartment or reaches any live parts!</li> <li>As our products are subject to technical modifications, we cannot guarantee, that all information is always up to date. Please contact our technical department with any queries.</li> <li>(Type Y) If the external flexible cable or cord of this luminaire is damaged, it shall be exclusively replaced by the manufacturer or his service agent or a similar qualified person in order to avoid a hazard.</li> <li>Do not cover the luminaires with insulating material.</li> <li>Do not use luminaires with frayed or cracked glass, until it is replaced</li> <li>Not hang or supporting elements on the luminaires.</li> <li>If the flexible cable or cord of this luminaire is damaged, it should be replaced only by the manufacturer or its service or equivalent qualified or a person of equivalent qualification in order to avoid any risk.</li> </ol>	<p>Caractéristiques techniques : voir l'étiquette de la lampe</p> <p><b>CONSIGNES DE SECURITE</b></p> <ol style="list-style-type: none"> <li>Les branchements ne doivent être confiés qu'à une personne compétente.</li> <li>Attention ! Couper la ligne d'alimentation avant de commencer les travaux d'assemblage ; retirer le fusible ou mettre l'interrupteur sur "ARRET" ! Pour le branchement à la ligne d'alimentation voir les figures ci-dessous.</li> <li>Cette lampe ne peut être utilisée que dans des appartements (pas dans des locaux humides !). Elle ne doit être installée qu'en conformité avec sa conception. La température ambiante maximale autorisée est de 25°C.</li> <li>Ne pas monter la lampe sur une surface de fixation humide, récemment peinte ou susceptible d'être conducteur électrique.</li> <li>Réalisez la connexion des câbles de la lampe avec ceux de la même couleur sortant du mur ou du plafond.</li> <li>Utilisez les systèmes de fixation correspondants, en fonction du poids de l'appareil.</li> <li>Maintenez toujours les connexions et les câbles éloignés des sources de chaleur.</li> <li>Assurez-vous que les vis de fixation de la lampe ne peuvent endommager les conduites d'installation.</li> <li>Nous vous conseillons de conserver ce mode d'emploi.</li> <li>Utilisez protecteurs pour les câbles d'alimentation.</li> <li>L'entretien se limite aux surfaces extérieures, aux écrans ou aux verres, aux réflecteurs et aux caches. Veiller à ce que l'humidité en puisse pas s'infiltrer dans les boîtes de jonction ou sur les pièces conductrices de courant. Nettoyer les lampes dorées ou en laiton qu'avec un chiffon doux et humide (sans produit nettoyant).</li> <li>Nos produits sont susceptibles d'être modifiés techniquement ou optimisés. Par conséquent, nous ne pouvons pas garantir que toutes les informations de cette fiche technique soient à jour. Notre service technique se tient à votre entière disposition pour toute information.</li> <li>(Type Y) Si le câble flexible de ce luminaire est endommagé, seul le fabricant ou l'assistance technique doivent le remplacer pour éviter tout risque.</li> <li>Ne pas couvrir le luminaire avec du matériau isolant.</li> <li>Les luminaires avec un filtre endommagé ou cassé seront mis hors service jusqu'au remplacement de celui-ci.</li> <li>Ne rien pendre ni appuyer sur les luminaires.</li> <li>Si le câble ou le cordon flexible de ce luminaire est endommagé, il doit être être remplacé uniquement par le fabricant, son agent de service ou une personne de niveau équivalent. service ou une personne de qualification équivalente afin d'éviter tout risque.</li> </ol>	

 <p>Luminaria de acero inoxidable que precisa de un mantenimiento periódico.</p>	<p>Stainless steel luminaire which requires periodical maintenance.</p>	<p>Luminaire de acier inoxydable qui a besoin de maintenance périodique.</p>	 <p>Luminaria o poste de resina que precisa de mantenimiento periódico con aceite sintético para recuperar el brillo.</p>	<p>Resin luminaries or posts that require a periodic maintenance with synthetic oil to restore the brightness.</p>	<p>Luminaire ou mât à résine qui peut nécessiter d'un entretien à l'huile synthétique pour récupérer son aspect d'origine.</p>
 <p>Luminaria de latón que precisa de mantenimiento periódico con pulimento específico para recuperar el brillo.</p>	<p>Resin luminaries or posts that require a periodic maintenance with specific polishing to restore the brightness.</p>	<p>Luminaire à laiton qui peut nécessiter d'un entretien à polissage spécifique pour récupérer son aspect d'origine.</p>	 <p>Acabado del poste de acero cincado con lo que debe pintarse forzosamente una vez instalado.</p>	<p>Post is finished in zinc-plated steel and therefore must be painted once installed.</p>	<p>Mât en acier Galvanisé ce qui doit nécessairement être peint une fois installé</p>

**SIMBOLOGÍA / SYMBOLOGY / SYMBOLISME:**

	<p><b>ES</b> Clase de protección I: La luminaria dispone de un conector para el cable de protección (toma tierra). <b>EN</b> Protection class I: This luminaire has an earth terminal. <b>F</b> Classe de protection I: Ce luminaire dispose d'un connecteur pour le câble de protection.</p>		<p><b>ES</b> Luminaria no adecuada para cubrirse con material aislante térmico <b>EN</b> Luminaires not suitable for covering with thermally insulating material <b>F</b> Ne pas recouvrir le luminaire avec du matériau isolant.</p>
	<p><b>ES</b> Clase de protección II: La luminaria tiene doble aislamiento y no se debe conectar a un cable de protección <b>EN</b> Protection class II: This luminaire is doubly insulated and must not be connected to and earth wire. <b>F</b> Classe de protection II: Ce luminaire a un double isolement et il ne faut pas le connecter à un câble de protection.</p>		<p><b>ES</b> Sustituir pantalla de protección con fisuras. <b>EN</b> Replace any cracked protective Shield <b>F</b> Remplacez le verre de sécurité fissuré.</p>
	<p><b>ES</b> Clase de protección III: Luminaria para muy baja tensión de protección (MBTS). <b>EN</b> Protection class III: Luminaire for protective low voltage (SELV) <b>F</b> Classe de protection III: Luminaire pour la protection de basse pression (SELV).</p>		<p><b>ES</b> El símbolo de la papelera tachada en el aparato o en el embalaje, indica que el producto al final de su vida deberá eliminarse por separado de los demás desechos. <b>EN</b> Where affixed on the equipment or package, the barred waste bin sign indicates that the product must be separated from other waste at the end of its working life for disposal. <b>F</b> Le symbole avec la poubelle barrée, mis sur l'appareillage ou sur l'emballage, indique que le produit arrivé à la fin de sa vie utile doit être éliminé séparément des autres déchets.</p>
	<p><b>ES</b> Distancia mínima de los objetos iluminados. <b>EN</b> Minimum distance from lighted objects <b>F</b> Distance minimale des objets éclairés</p>		<p><b>ES</b> Componente de control reemplazable por un profesional. <b>EN</b> Replaceable control gear by a professional. <b>F</b> Appareils de contrôle remplaçables par un professionnel.</p>
	<p><b>ES</b> Baja Presión= Luminaria diseñada para la utilización únicamente de lámparas halógenas de volframio autoprotégidas <b>EN</b> Low pressure: For luminaries which are designed for use with self-shielded tungsten halogen lamps only. <b>F</b> Basse pression = Luminaire dessiné pour l'utilisation uniquement avec lampes halogènes de tungstène auto protégées.</p>		<p><b>ES</b> Componente de control reemplazable por el usuario final. <b>EN</b> Replaceable control gear by an end-user. <b>F</b> Appareil de commande remplaçable par l'utilisateur final.</p>
	<p><b>ES</b> Luminaria empotrada no adecuada para montaje en normalmente superficies inflamables <b>EN</b> Recessed luminaire not suitable for direct mounting on normally flammable surfaces <b>F</b> Luminaire construit non approprié pour le montage sur des surfaces normalement inflammables.</p>		<p><b>ES</b> Fuente de luz reemplazable por un profesional. <b>EN</b> Replaceable light source by a professional. <b>F</b> Remplacez le verre de sécurité fissuré.</p>
	<p><b>ES</b> Luminaria superficial no adecuada para montaje en superficies normalmente inflamables <b>EN</b> Surface luminaire not suitable for direct mounting on normally flammable surfaces. <b>F</b> Luminaire superficial non approprié pour le montage sur des surfaces normalement inflammables.</p>		<p><b>ES</b> Fuente de luz reemplazable por el usuario final. <b>EN</b> Replaceable light source by an end-user. <b>F</b> Remplacer la source lumineuse par un utilisateur final.</p>
			<p><b>ES</b> Fuente de luz no reemplazable. <b>EN</b> Non-replaceable light source. <b>F</b> Source lumineuse non remplaçable.</p>

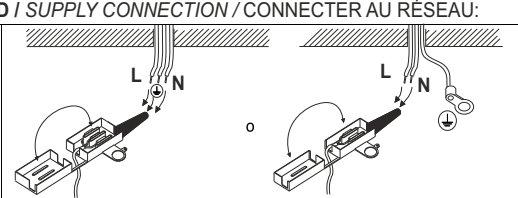
**CONEXIÓN A RED / SUPPLY CONNECTION / CONNECTER AU RÉSEAU:**

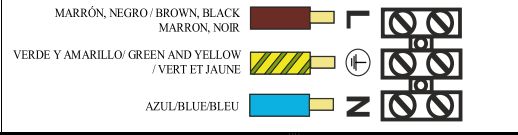
	 <p>MARRÓN, NEGRO / BROWN, BLACK MARRON, NOIR</p> <p>VERDE Y AMARILLO / GREEN AND YELLOW / VERT ET JAUNE</p> <p>AZUL/BLUE/BLEU</p>
	 <p>MARRÓN, NEGRO / BROWN, BLACK MARRON, NOIR</p> <p>AZUL/BLUE/BLEU</p>

**IP66** ES: Protegido contra el polvo y chorros fuertes de agua.  
EN: Dust protected and protected against rough seas.  
F: Protégé contre la poussière et les jets d'eau à pression.