

1. SWITCH OFF MAIN
2. MAKE HOLE PATTERN
3. INSTALL THE BASE PLATE
4. CONNECT LAMP TO THE MAIN
5. DRIVE IN THE SCREWS UNTILL TIGHT
6. SWITCH ON THE MAIN AND LIGHT ON

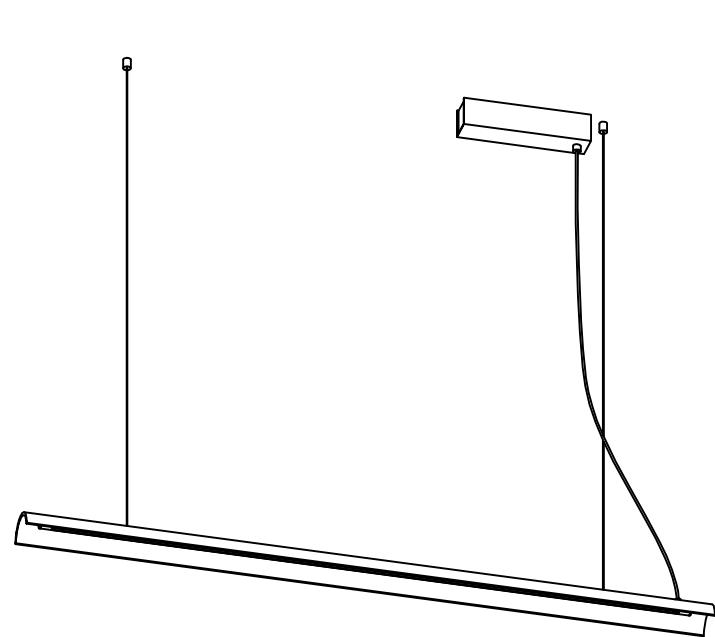

PL372
L1300xW80xH1200(mm)
LED-17W

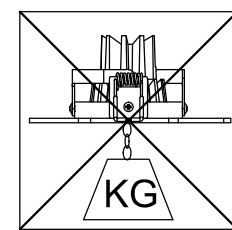
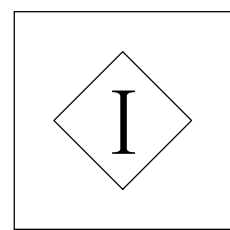
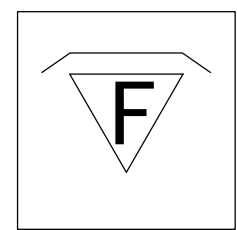
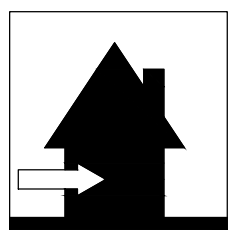
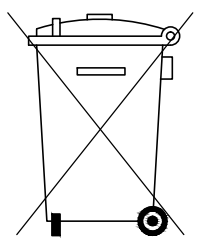
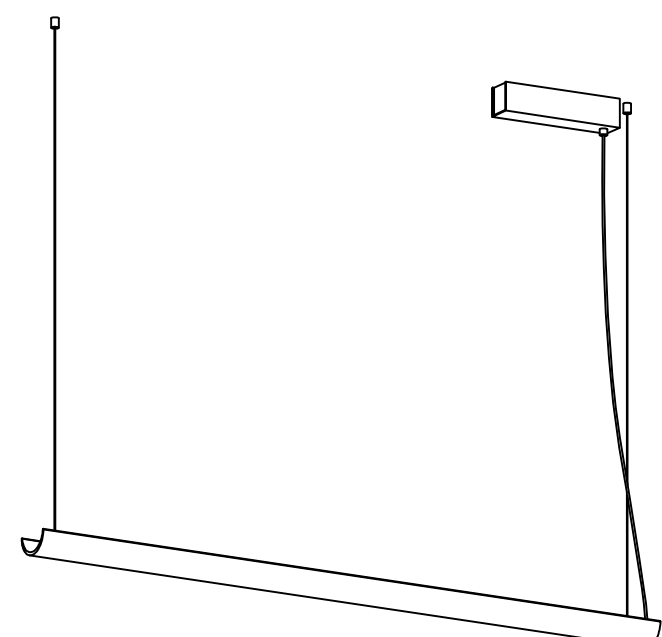

PL373
L1300xW80xH1200(mm)
LED-17W

Lamp : SMD-2835 LED
 Color : 2700K/3000K/4000K/6000K
 Color rendering : Ra80
 Input : 220V-240V AC
 Current : Constant 300mA
 Frequency : 50/60Hz
 Watt : 17W
 Life span : 20,000hrs
 Operating temp : -20°C --+40°C
 Indoor use only
 IP20
 Dimmable : NO

Cautions: a. Installed by qualified electrician
 b. Use only power-supply supplied by manufacturer for products guarantee