

- 01.SWITCH OFF MAIN
- 02.MAKE HOLE PATTERN
- 03.INSTALL THE BASE PLATE
- 04.CONNECT LAMP TO THE MAIN
- 05.DRIVE IN THE SCREWS UNTILL TIGHT
- 06.SWITCH ON THE MAIN AND LIGHT ON

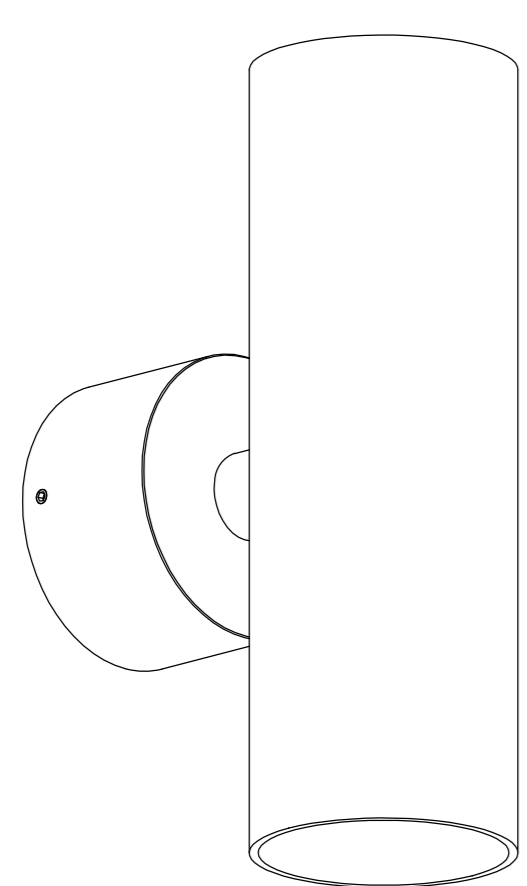

S031
L112xW60xH110(mm)
GU10-LED5W

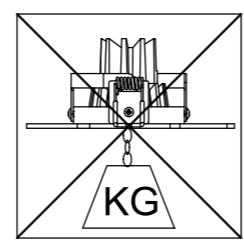
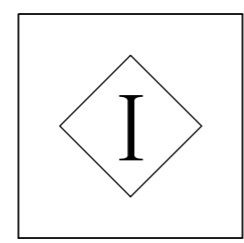
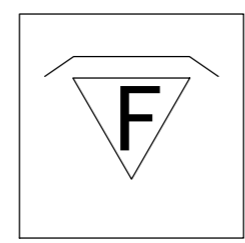
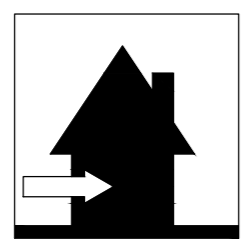
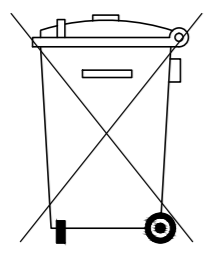
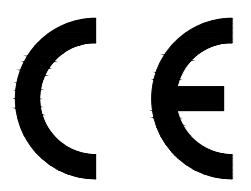
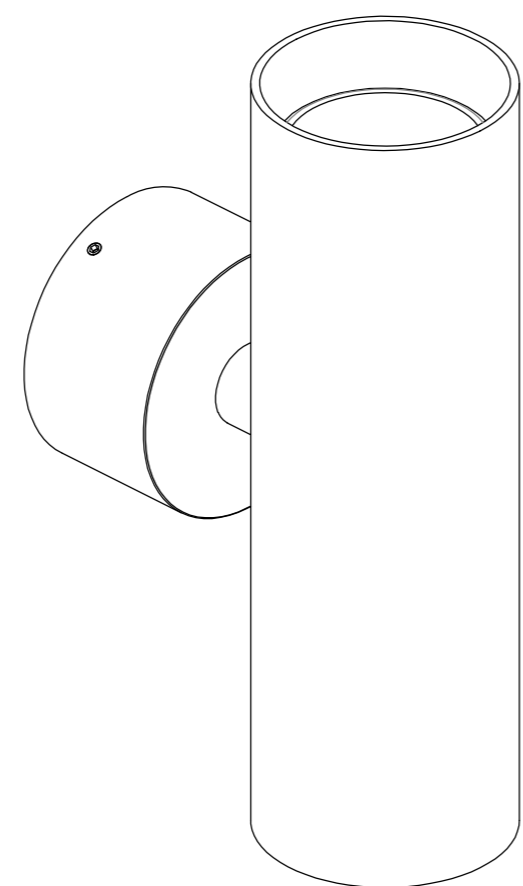

S032
L112xW60xH190(mm)
GU10-LED2x5W

Lamp:GU10-LED 5W
 Input: 220V-240V AC
 Frequency: 50/60Hz
 Watt:5W/2X5W
 Life span: 2,000hrs
 Operating temp: -20°C-+40°C
 Indoor use only
 IP20
 Dimmable: NO

Cautions: a.Installed by qualified electrician
 b.Use only power-supply supplied
 by manufacturer for products guarantee