

- 01.SWITCH OFF MAIN
- 02.MAKE HOLE PATTERN
- 03.INSTALL THE BASE PLATE
- 04.CONNECT LAMP TO THE MAIN
- 05.DRIVE IN THE SCREWS UNTILL TIGHT
- 06.SWITCH ON THE MAIN AND LIGHT ON

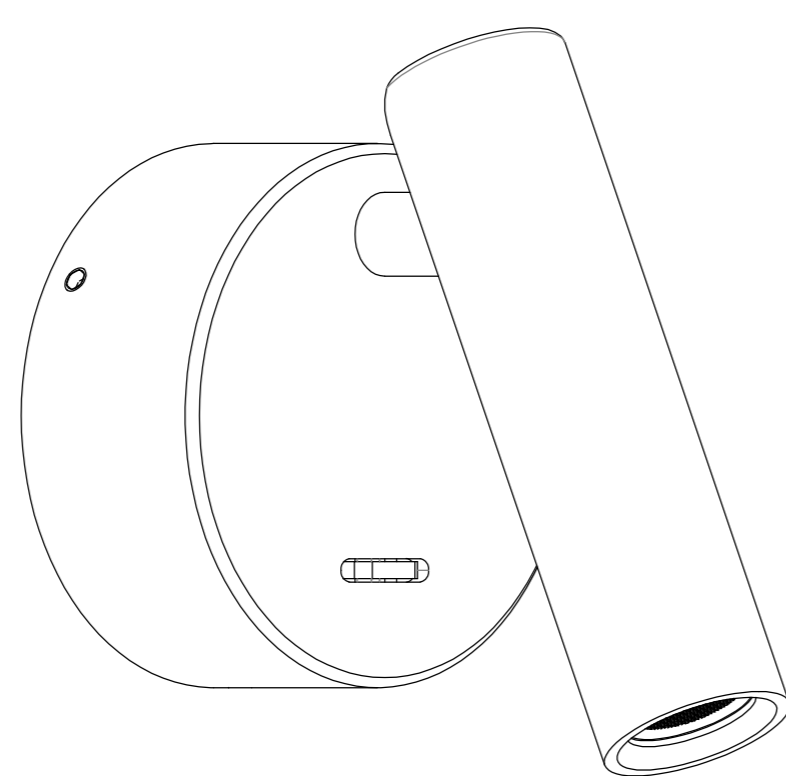
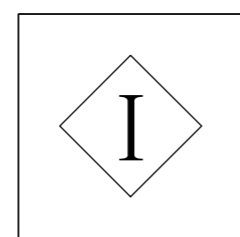
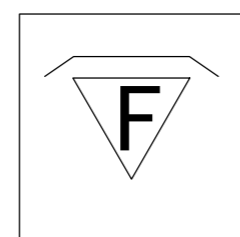
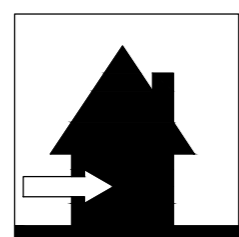
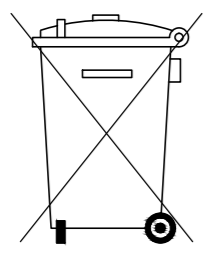
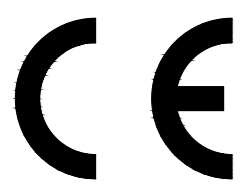

WA330  
L110xW86xH81(mm)  
LED-3W

Lamp:CREE XPE LED  
 Color: 2700K/3000K/4000K/6000K  
 Color rendering: Ra80  
 Input: 100V-240V AC  
 Current: Constant 700mA  
 Frequency: 50/60Hz  
 Watt: 3W  
 Life span: 20,000hrs  
 Operating temp: -20°C--+40°C  
 Indoor use only  
 IP20  
 Dimmable: NO

Cautions: a.Installed by qualified electrician  
 b.Use only power-supply supplied  
 by manufacturer for products guarantee