

- 01.SWITCH OFF MAIN
- 02.MAKE HOLE PATTERN
- 03.INSTALL THE BASE PLATE
- 04.CONNECT LAMP TO THE MAIN
- 05.DRIVE IN THE SCREWS UNTILL TIGHT
- 06.SWITCH ON THE MAIN AND LIGHT ON

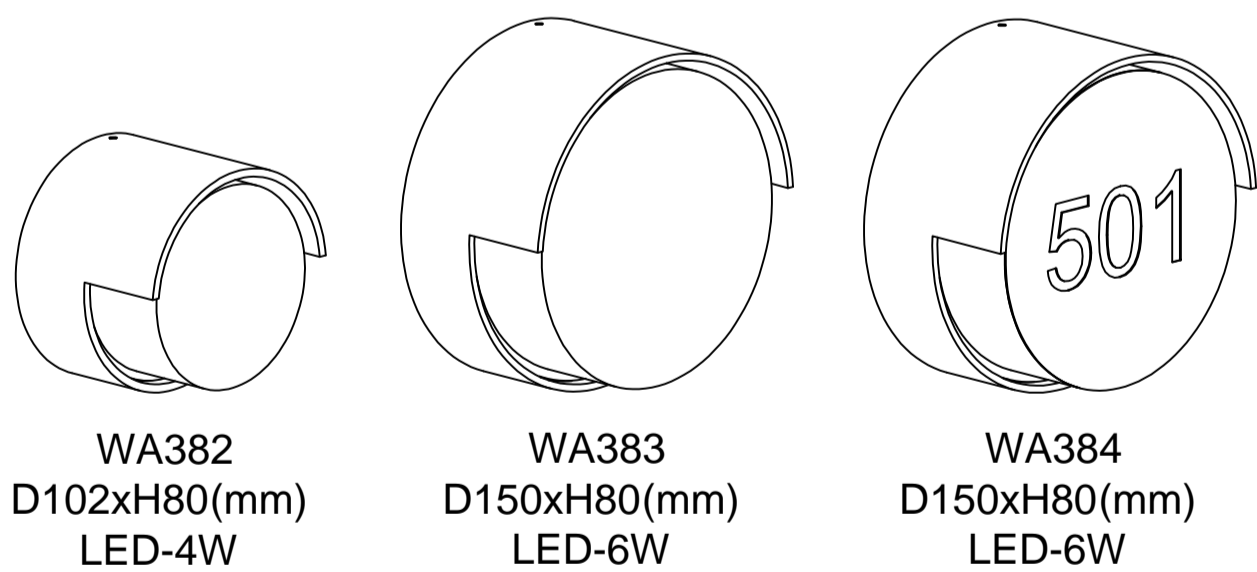
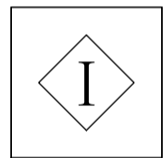
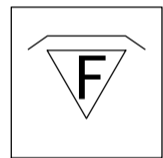
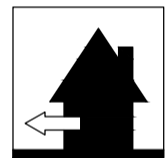
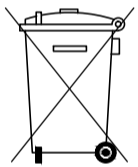

WA382
D102xH80(mm)
LED-4W

WA383
D150xH80(mm)
LED-6W

WA384
D150xH80(mm)
LED-6W

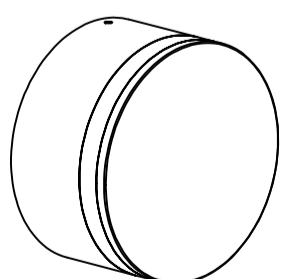

WA385
D102xH55(mm)
LED-4W

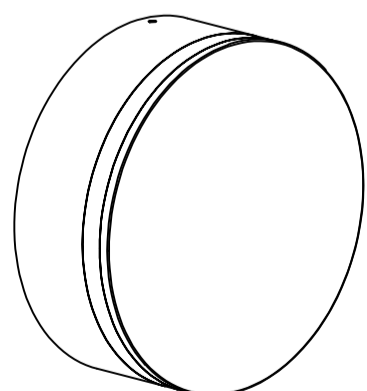

WA386
D150xH55(mm)
LED-12W

Lamp : SMD-2835 LED
 Color : 2700K/3000K/4000K/6000K
 Color rendering : Ra80
 Input : 100V-240V AC
 Current : Constant 300mA
 Frequency : 50/60Hz
 Watt : 4W/6W/12W
 Life span : 20,000hrs
 Operating temp : -20°C--+40°C
 IP65
 Dimmable : NO

Cautions: a.Installed by qualified electrician
 b.Use only power-supply supplied
 by manufacturer for products guarantee