

Dea Eros-Q1/Q2 XS PE

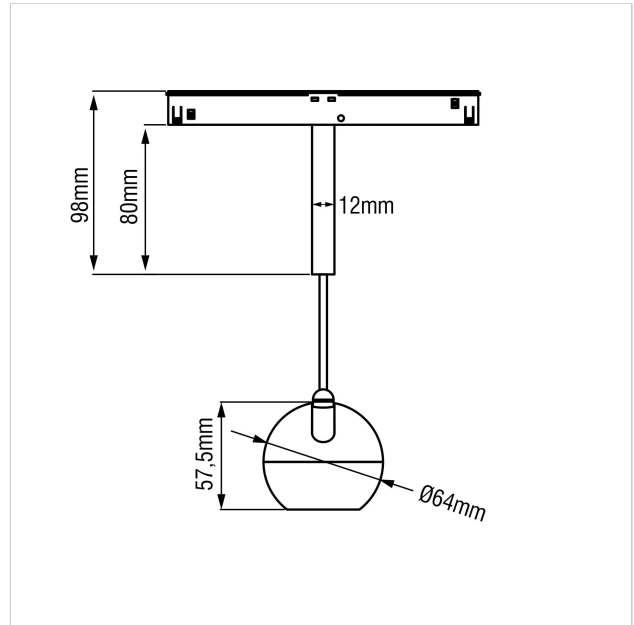

SKU	: Q508BW94034WHF0
Housing material	: Aluminum Die Cast
Luminaire Color	: White
Optic	: Reflector
Reflector Color	: White
Power supply	: Included ON/OFF
Luminous Flux (lm)	: 510lm
System power	: 7W
System efficiency	: 73lm/W
Beam angle (°)	: 34°
CCT (K)	: 4000K
CRI	: 90
Chromaticity tolerance	: 3 MacAdam
Mains Voltage	: 220-240V / 50 -60Hz
EI. Class	: Class III
Lifetime	: 50000h
IP rating	: IP20
Light source energy class	:
Light source identifier	:
Net. Weight	: 0.225Kg
Warranty	: 5Y

All rated values @ ambient temperature of 25° C. Electric and photometric values are initially subject to a tolerance of +/- 10%. Tolerance of color temperature +/- 150K. Technical data can change without prior notice.

©2022 Karizma Luce BV. All rights reserved. Please visit karizmaluce.com for more information.