

# Dea Flora S

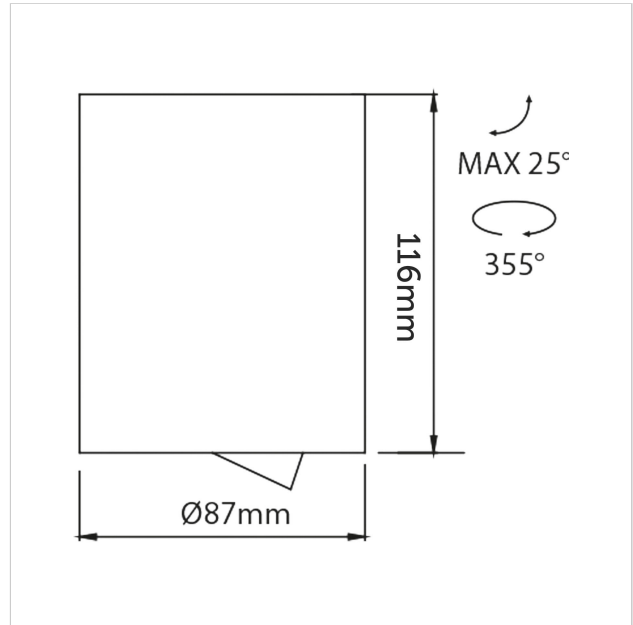

<b>SKU</b>	: 402DW94040SGF0
<b>Housing material</b>	: Aluminum Die Cast
<b>Luminaire Color</b>	: White
<b>Optic</b>	: Reflector
<b>Reflector Color</b>	: Silver High Gloss
<b>Power supply</b>	: Included ON/OFF
<b>Luminaire dimension</b>	: Ø87x116mm
<b>Cut out dimension</b>	: N/A
<b>Luminous Flux (lm)</b>	: 960 lm
<b>LED power</b>	: N/A
<b>System power</b>	: 10.5W
<b>System efficiency</b>	: 91lm/W
<b>Beam angle (°)</b>	: 40°
<b>CCT (K)</b>	: 4000K
<b>CRI</b>	: 90
<b>Chromaticity tolerance</b>	: 3 MacAdam
<b>Nominal fA</b>	: N/A
<b>Nominal fV</b>	: N/A
<b>Mains Voltage</b>	: 220-240V / 50 -60Hz
<b>El. Class</b>	: Class II
<b>Lifetime</b>	: 50000h
<b>IP rating</b>	: IP20

---

<b>Light source energy class</b>	: E
<b>Light source identifier</b>	: CLU028-1204C4-403H5M3-F1
<b>Net. Weight</b>	: 0.58Kg
<b>Warranty</b>	: 5Y

---

All rated values @ ambient temperature of 25° C. Electric and photometric values are initially subject to a tolerance of +/- 10%. Tolerance of color temperature +/- 150K. Technical data can change without prior notice.

©2022 Karizma Luce BV. All rights reserved. Please visit [karizmaluce.com](http://karizmaluce.com) for more information.