

Dea Juno M

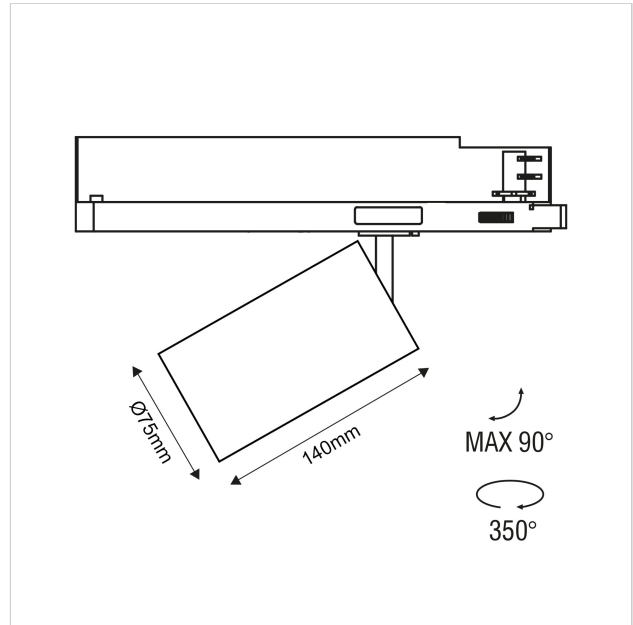

SKU	: 607HW93040SGF0
Housing material	: Aluminum Die Cast
Luminaire Color	: White
Optic	: Reflector
Reflector Color	: Silver High Gloss
Power supply	: Included ON/OFF
Luminaire dimension	: Ø75x140mm
Cut out dimension	: N/A
Luminous Flux (lm)	: 1750 lm
LED power	: N/A
System power	: 20W
System efficiency	: 88lm/W
Beam angle (°)	: 40°
CCT (K)	: 3000K
CRI	: 90
Chromaticity tolerance	: 3 MacAdam
Nominal fA	: N/A
Nominal fV	: N/A
Mains Voltage	: 220-240V / 50 -60Hz
EI. Class	: Class II
Lifetime	: 50000h
IP rating	: IP20

Light source energy class	: E
Light source identifier	: CLU028-1204C4-303H5M3-F1
Net. Weight	: 0.68Kg
Warranty	: 5Y

All rated values @ ambient temperature of 25° C. Electric and photometric values are initially subject to a tolerance of +/- 10%. Tolerance of color temperature +/- 150K. Technical data can change without prior notice.

©2022 Karizma Luce BV. All rights reserved. Please visit karizmaluce.com for more information.